

Rite Aid GEM

Installation Instructions

2 people required for installation

Tools Required

- Philips Screwdriver
- Utility Knife or Box Cutter to open boxes
- Additional tools may be required due to unseen store environmental conditions

Gondola Specifications

- LOZIER or MADIX
- 66" Height x 16" Base Depth
- 13" and 15" shelves

Rite Aid Provides

- Plan-O-Gram (POG) for store specific GEM Program layout
- All power outlets under base decks, near end caps and for canopy headers
- Demerchandising of shelves in GEM area
- Existing end cap removal in locations where GEM end caps will reside
- Removal of any adhesive residue on shelf top surfaces near front edge
- *Instrumental Beauty* product display for top shelf in *Skin Cleansing Systems* section (reference store provided POG for applicability)

IMPORTANT SAFETY INSTRUCTIONS

SAVE THESE INSTRUCTIONS

When using an electrical furnishing, basic precautions should always be followed, including the following:

Read all instructions before proceeding with installation.

DANGER - To reduce the risk of electric shock:

- Always unplug this furnishing from the electrical outlet before cleaning.

WARNING - To reduce the risk of burns, fire, electric shock, or injury to persons:

- Unplug from outlet before putting on or taking off parts.
- Close supervision is necessary when this furnishing is used by, or near children, invalids, or disabled persons.
- Use this furnishing only for its intended use as described in these instructions. Do not use attachments not recommended by the manufacturer.
- Never operate this furnishing if it has a damaged cord or plug, if it is not working properly, if it has been dropped or damaged, or dropped into water. Return the furnishing to a service center for examination and repair.
- Keep the cord away from heated surfaces.
- Never drop or insert any object into any opening.
- Do not use outdoors.
- To disconnect remove plug from outlet.
- For grounded products the following statement:
- Each surface intended to support a load shall have a corresponding statement in the use instructions specifying the maximum intended load for that surface in pounds (kilograms)

GROUNDING INSTRUCTIONS

For a grounded, cord-connected product rated max 15 amperes and intended for use on a nominal 120-volt supply circuit: This product is for use on a nominal 120-volt circuit and has a grounding plug that looks like the plug illustrated in sketch A (see **Figure 1**).

Make sure that the product is connected to an outlet having the same configuration as the plug. No adapter should be used with this product.

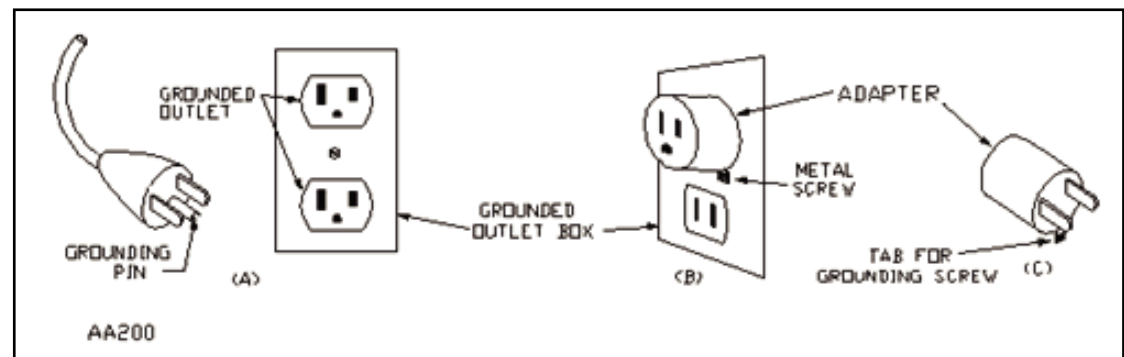

Figure 1 - Grounding Methods

Shelf Load Specification

Inline Components

(weights shown are max weights for product merchandising)

DO NOT PLACE
ANYTHING
ON THIS SURFACE

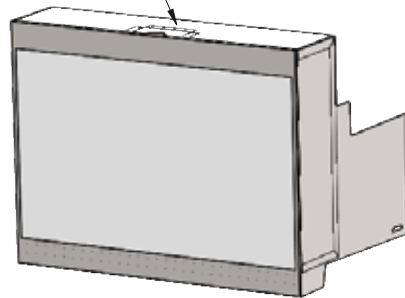

FOCAL LIGHT BOX

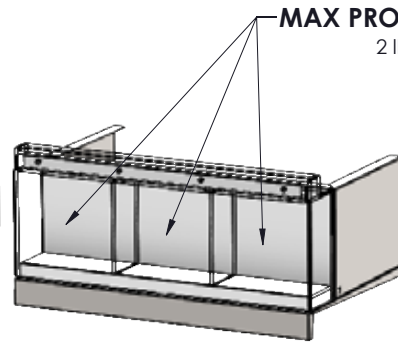

FOCAL PRODUCT DISPLAY

MAX PRODUCT WEIGHT
2 lbs. total

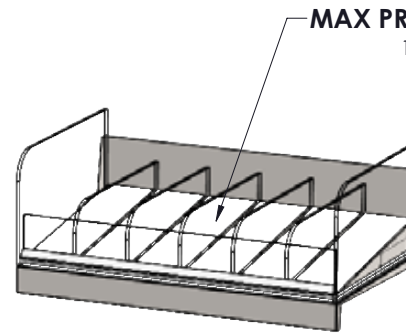

SHELF LINER CUBBIE

MAX PRODUCT WEIGHT
15 lbs. total

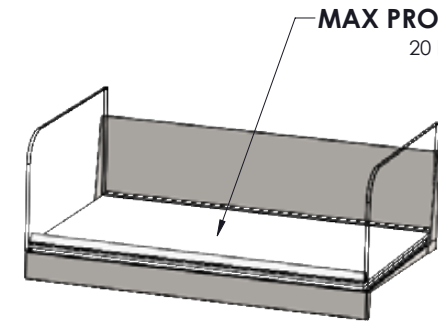

SHELF LINER

MAX PRODUCT WEIGHT
20 lbs. total

Shelf Load Specification

Endcap Components

(weights shown are max weights for product merchandising)

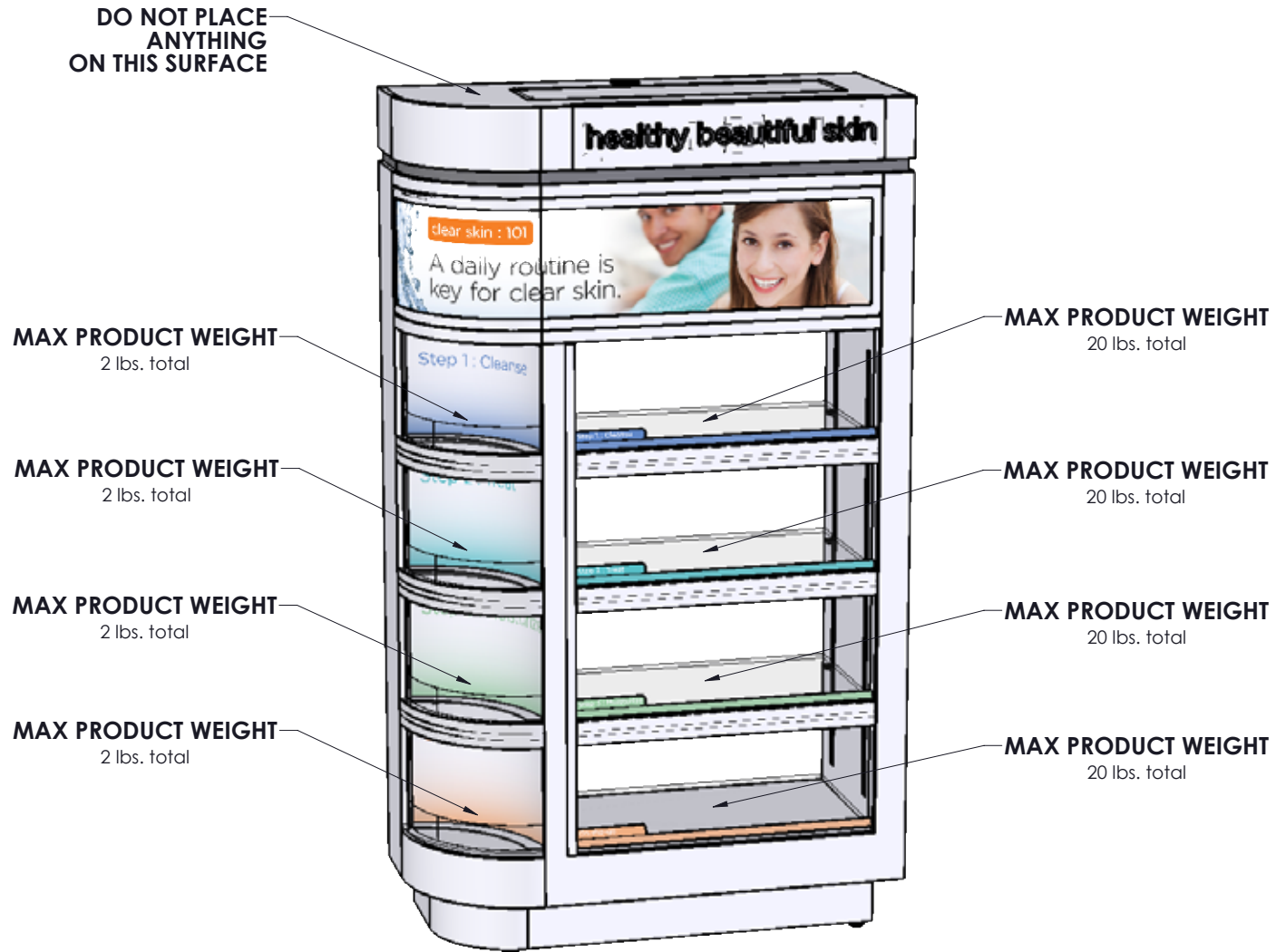

Gondola Shelf Height Placement

4 Shelf Scenario

(consult Rite Aid Plan-O-Gram (POG) for specific sections that apply)

START HERE

1. MUST ALWAYS BE SET ON 66" GONDOLA
2. THE 1ST HOLE ALWAYS STARTS FROM THE TOP
3. COUNT DOWN FROM 1ST HOLE TO PLACE ALL SHELVES

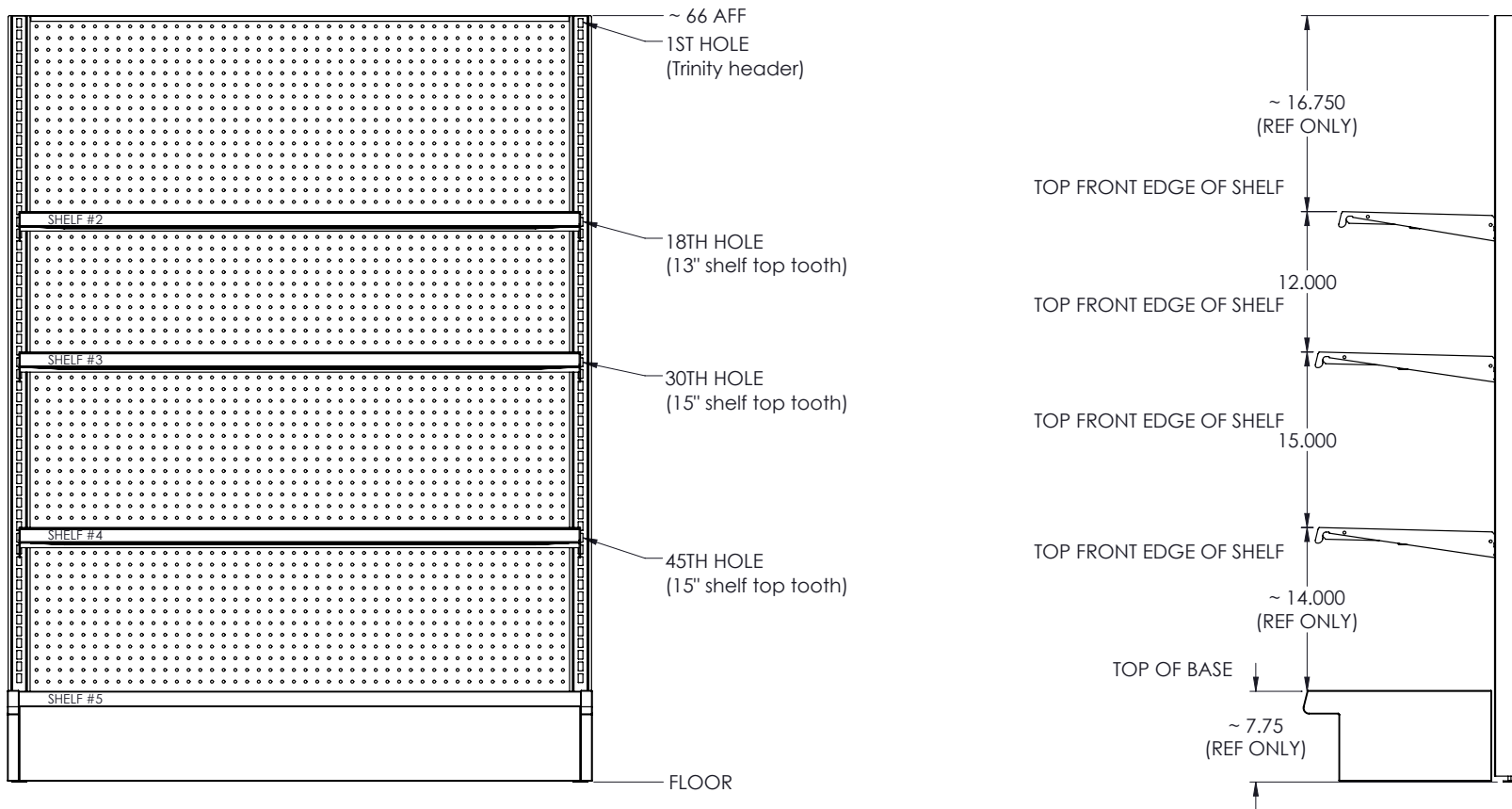

4 SHELF SCENARIO - 66" GONDOLA

Gondola Shelf Height Placement

5 Shelf Scenario

(consult Rite Aid Plan-O-Gram (POG) for specific sections that apply)

START HERE

1. MUST ALWAYS BE SET ON 66" GONDOLA
2. THE 1ST HOLE ALWAYS STARTS FROM THE TOP
3. COUNT DOWN FROM 1ST HOLE TO PLACE ALL SHELVES

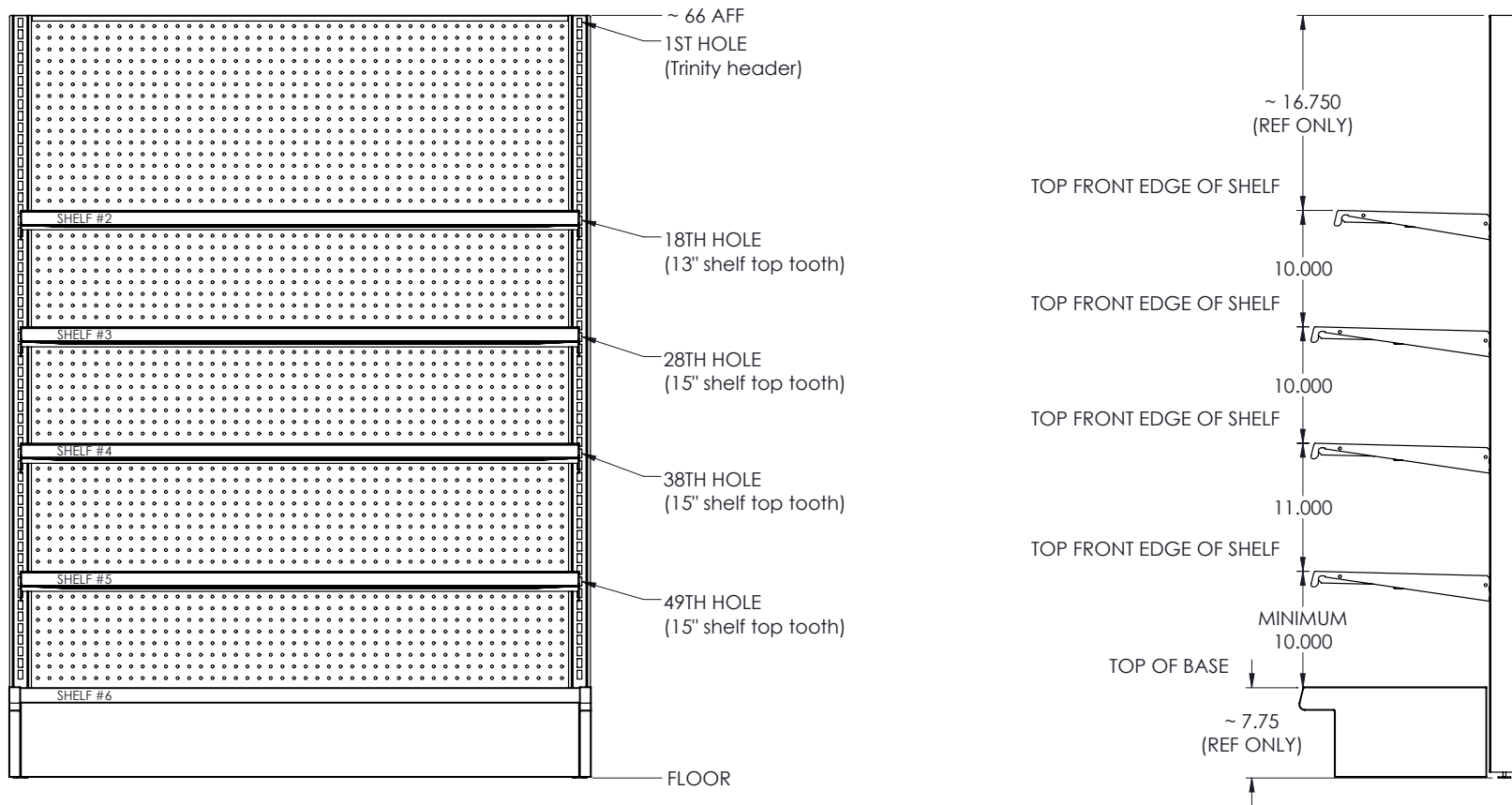

5 SHELF SCENARIO - 66" GONDOLA

Section Placement Guide

Reference Only

- Consult Rite Aid Plan-O-Gram (POG) for specific layout of sections
- Your store may not get all sections shown
- DETAIL A and DETAIL C may need to be reversed to fit your POG

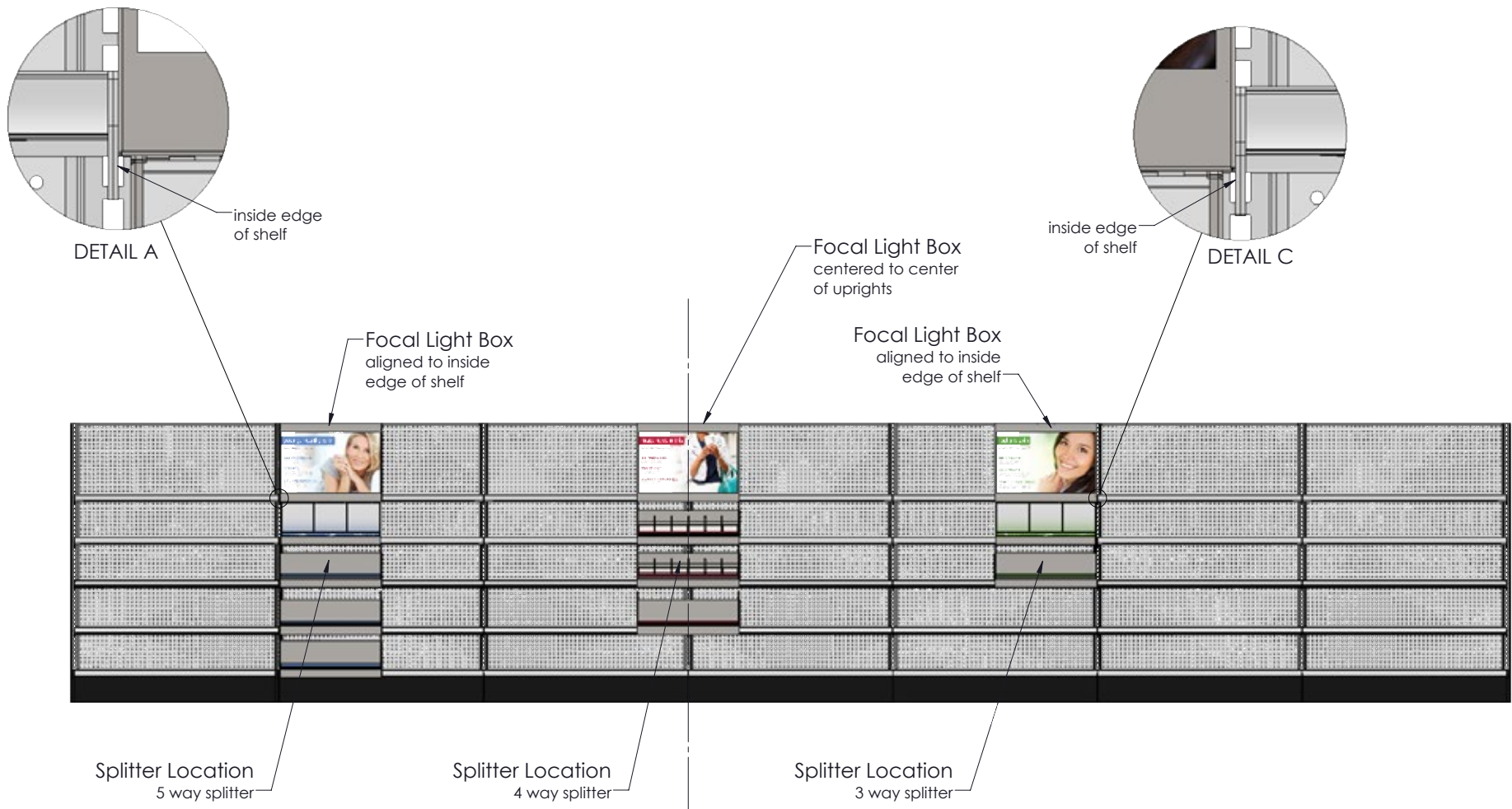

Section Placement Guide

Reference Only

- Consult Rite Aid Plan-O-Gram (POG) for specific layout of sections
- Your store may not get all sections shown

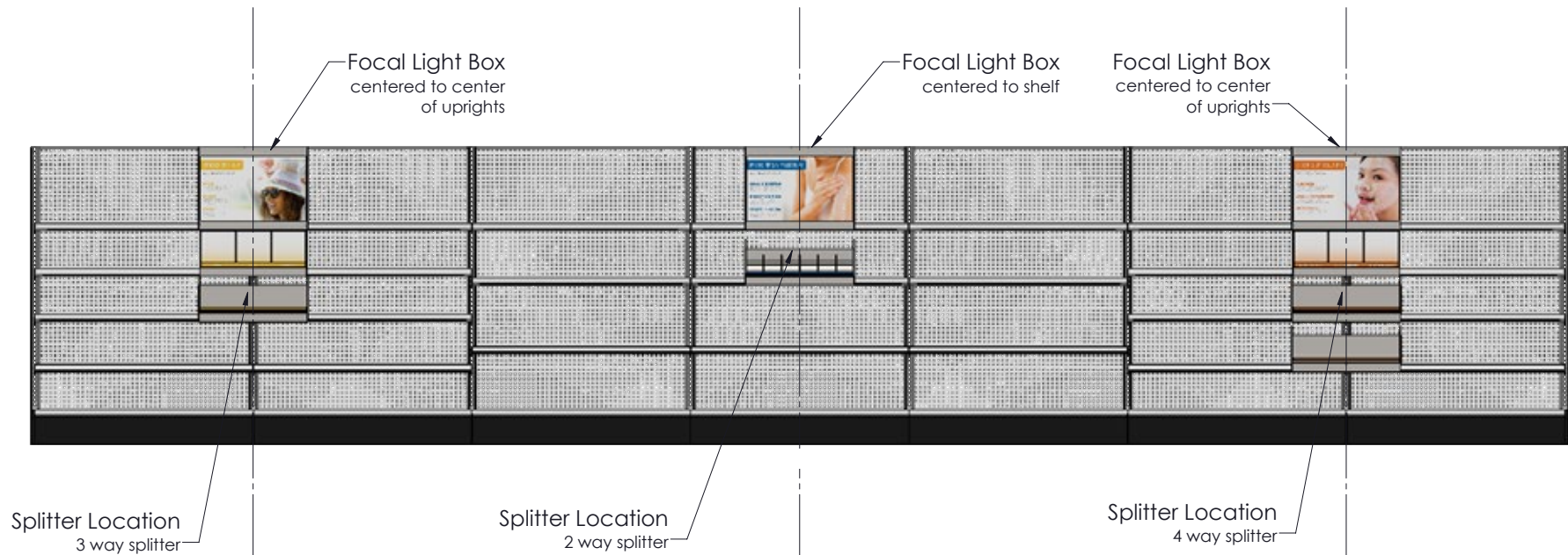

Component Layouts - GEM Facial

young, healthy skin

28' LT 28' RT 24' LT 24' RT

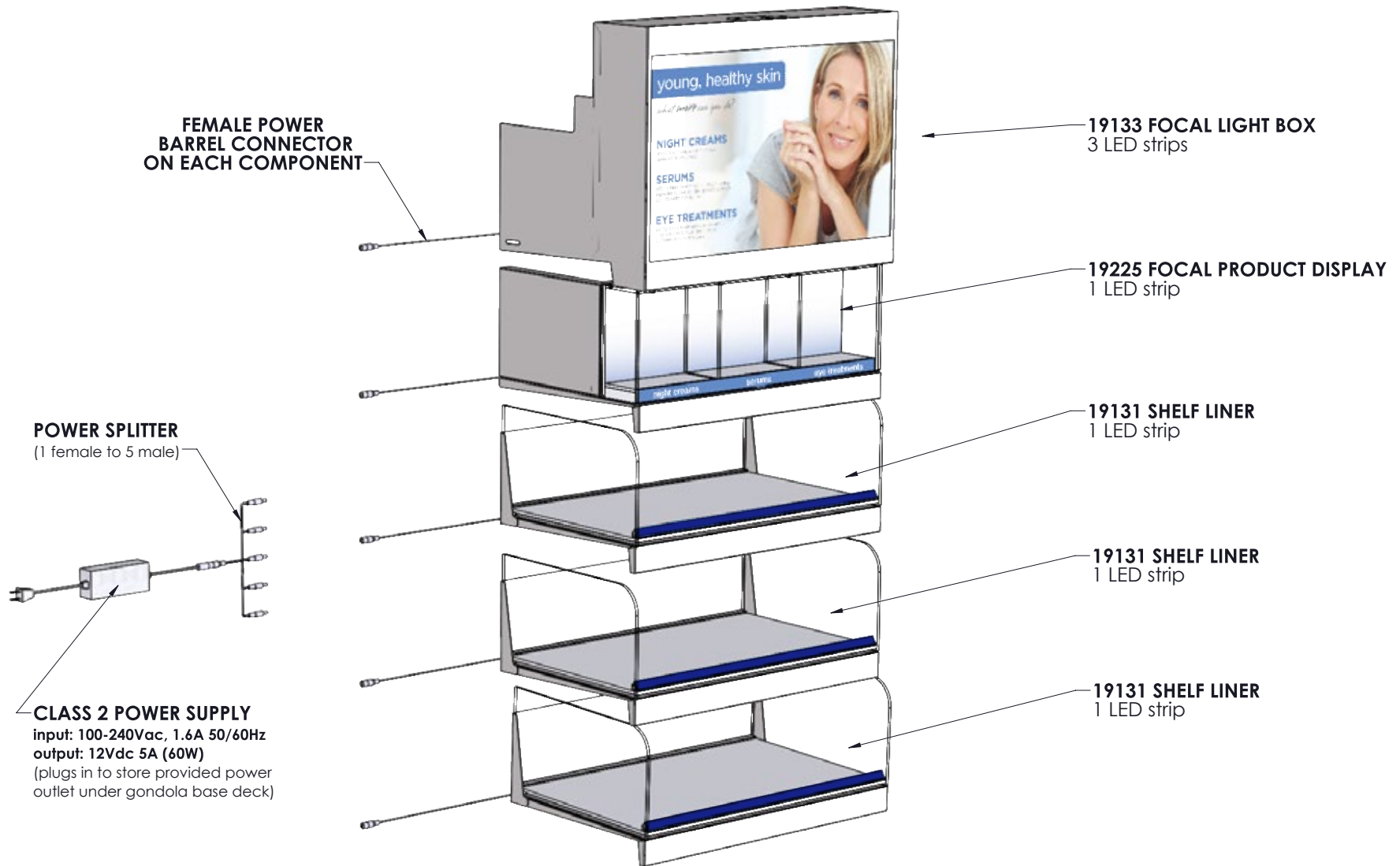

Component Layouts - GEM Facial

must-have minis

28' LT 28' RT 24' LT 24' RT

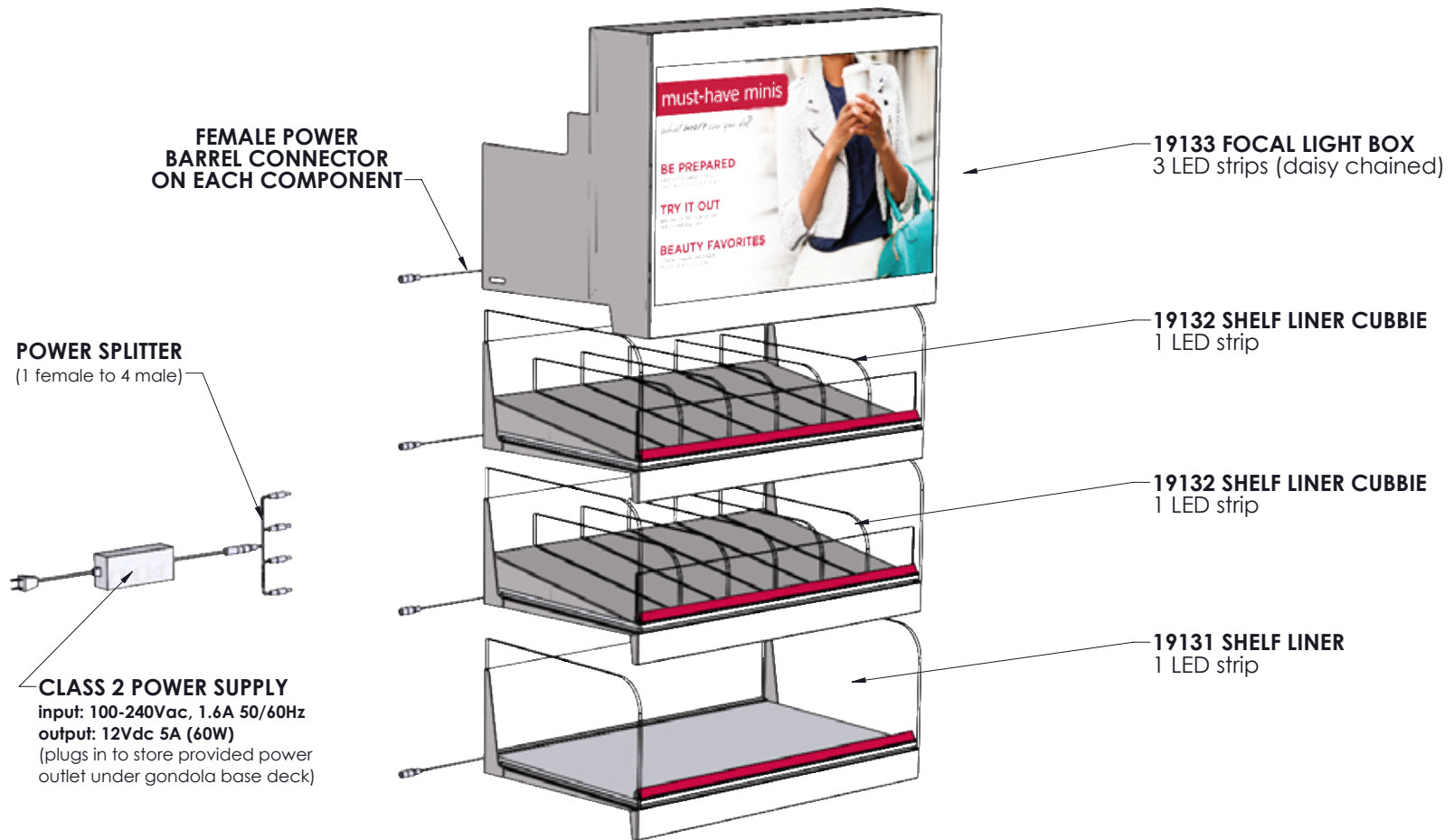

Component Layouts - GEM Facial radiant skin

28' LT 28' RT 24' LT 24' RT

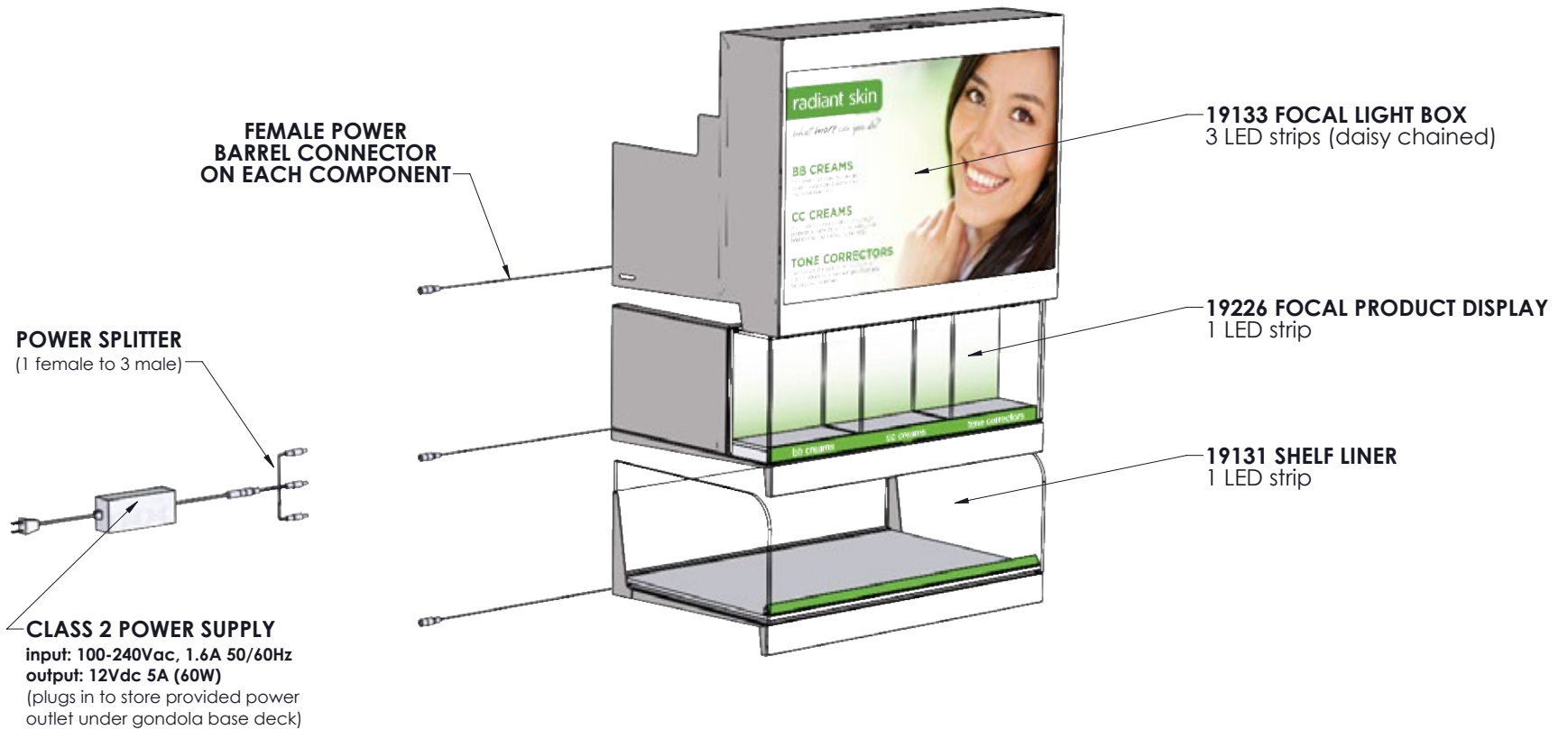

Component Layouts - GEM Depilatories and Sun shield the sun

8' LT 8' RT

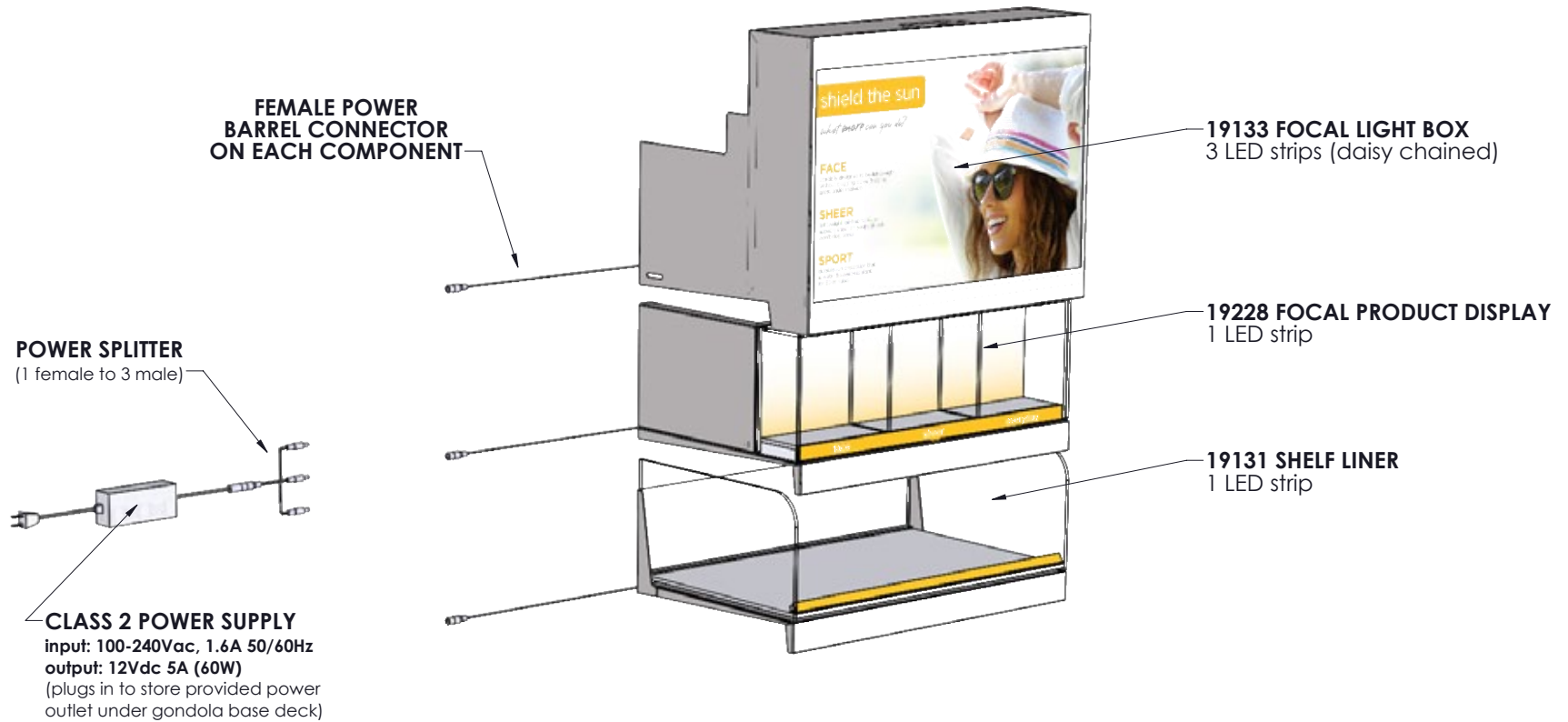

Component Layouts - GEM Hand & Body

more than moisture

20' LT 20' RT

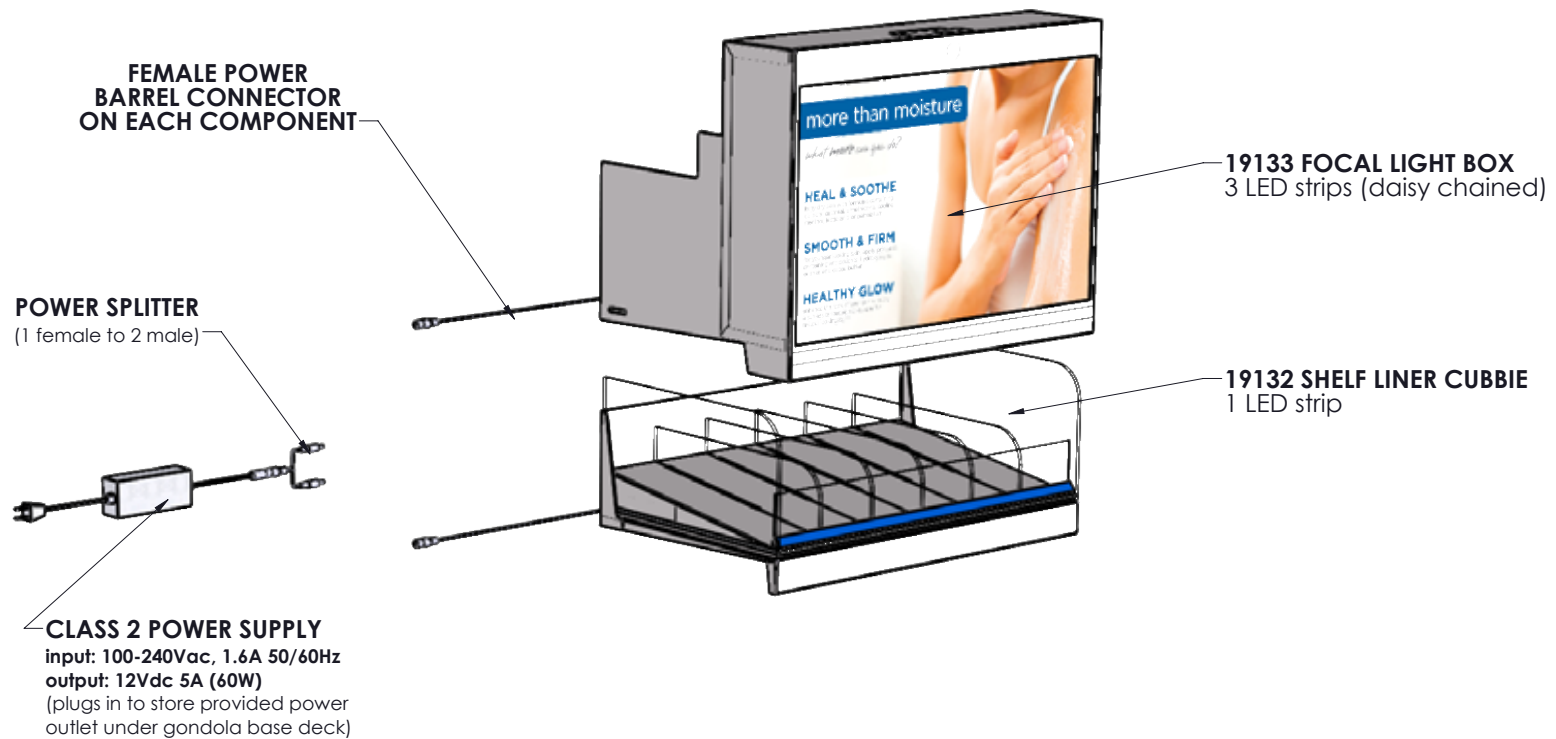

Component Layouts - GEM Hand & Body

clear skin routine

24' LT 24' RT 20' LT 20' RT

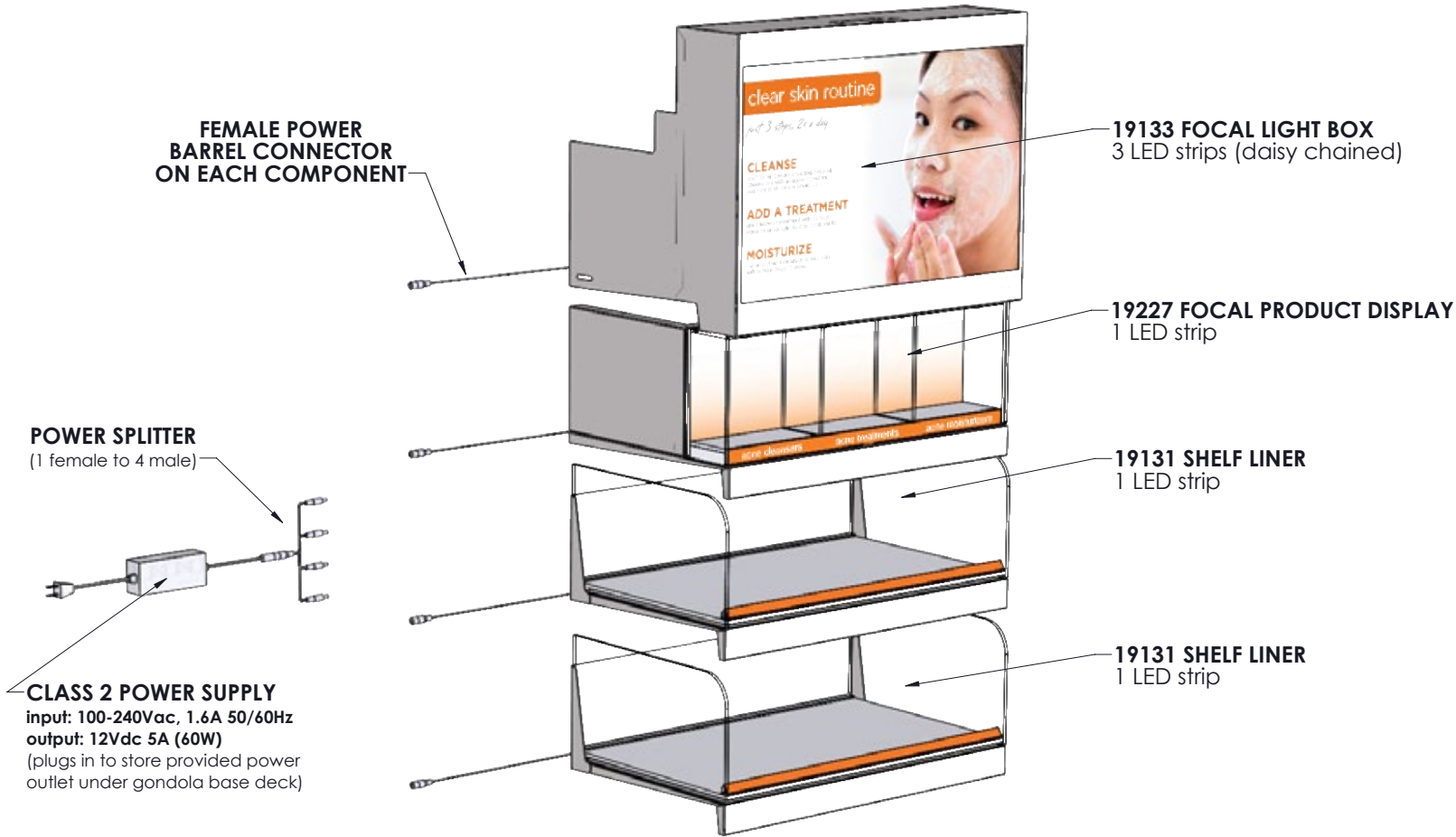

Wallpaper Installation

Dependent on Rite Aid supplied Plan-O-Gram (POG), you may have extra wallpaper and push-pins.

- 1 Place wallpaper so top push-pins are in 5th hole in pegboard, but do not push the pin yet.

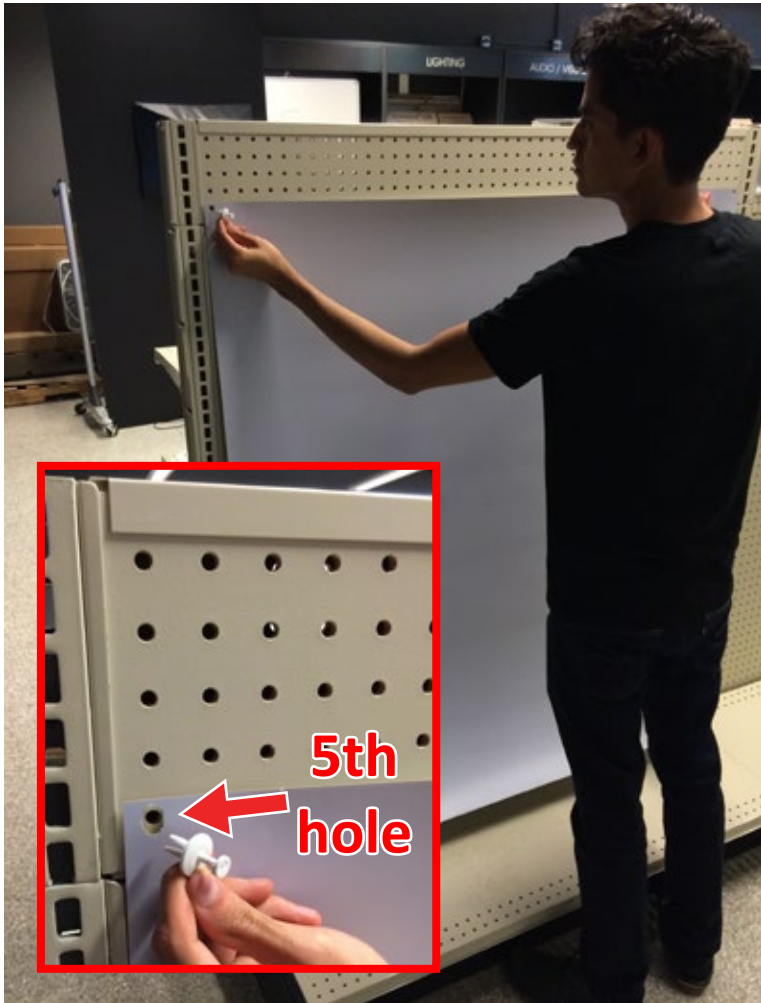

- 2 Place push-pins in pegboard through the bottom holes of the wallpaper, but do not push the pin yet. Smooth the wallpaper before pushing all pins in.

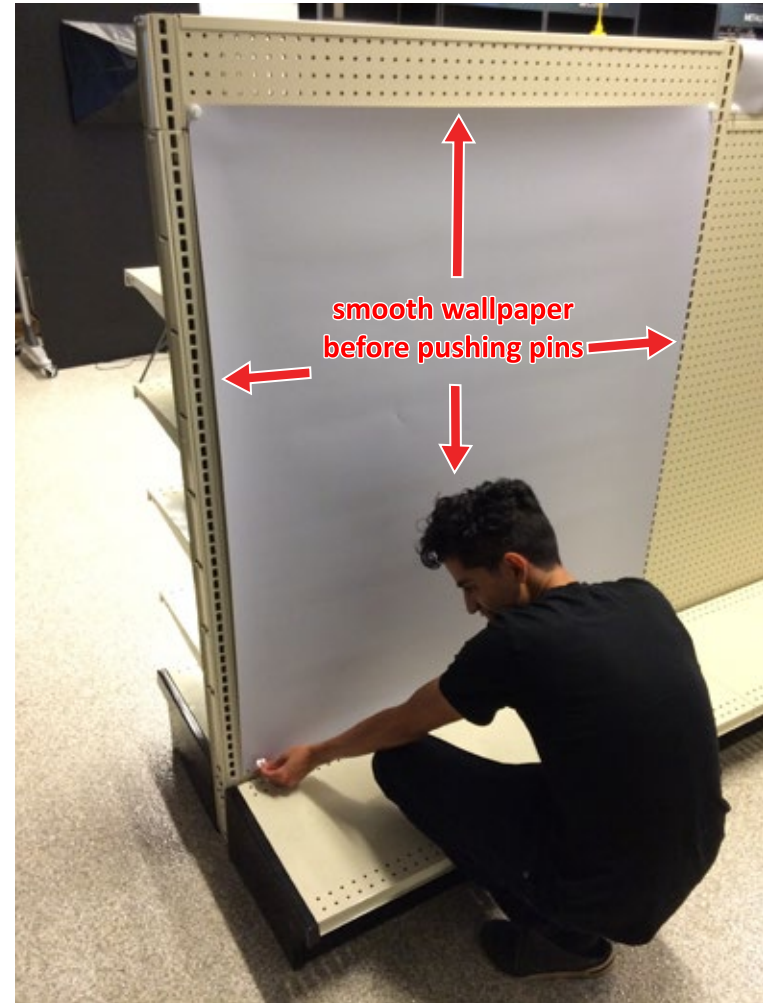

Trinity Canopy Headers Installation

Install 1 Trinity Canopy Header in each section of the POG using the instructions provided in the Canopy Header boxes.



! Install 1 canopy header in each POG section using the manufacturer's instruction sheet (Inline Headers) supplied in canopy header boxes.

Disregard step 14 (Inline Headers) in manufacturer supplied canopy header instructions. Peel off protective film from clear lenses and place aside for later steps.

! Dependent on Rite Aid supplied POG, you may be provided a set of Reverse Header Graphics. Discard un-needed set after confirming correct set to use.

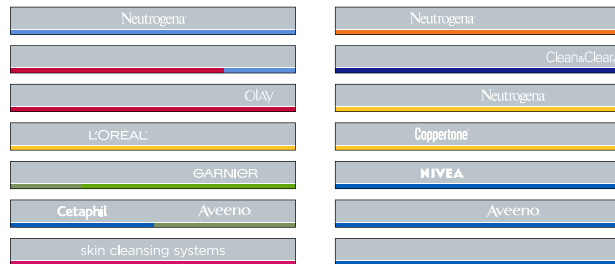

Reverse Header Graphics

1 A. Install info panel color graphics into clear channels with magnets.



B. Attach clear channels with magnets to metal lip on canopy headers. Consult Rite Aid supplied Plan-O-Gram (POG) for correct color placement.



2 A. Put header graphic in-between 2 clear lenses (ensure protective film is removed from clear lenses).



B. Slide header/clear lenses into each header.

Consult Rite Aid supplied Plan-O-Gram (POG) for correct color/logo placement.



Power Supply Placement - Inline Components

(reference *Component Layouts* & Rite Aid supplied Plan-O-Gram (POG) for locations to put power supplies/splitters).

- 1 Rotate base deck to expose store power. Plug power supply in and place power supply under base deck.



- 2 Person 1 disengages one side of base deck while person 2 routes power cord behind base deck. Re-engage base deck and rotate down into place.



- 3 Route power cord behind shelves until at splitter height (noted on *Section Placement Guide*).



- 4 Plug power cable in to appropriate splitter (noted on *Section Placement Guide*).



Focal Light Box Installation

(reference *Section Placement Guide* & Rite Aid supplied Plan-O-Gram (POG) for appropriate install locations)

- 1 A. Carefully remove **Focal Light Box** and place loose items aside until later steps. Remove tape.

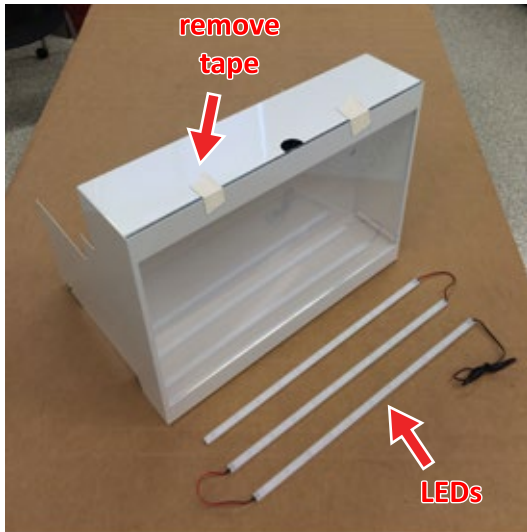

- B. Remove clear acrylic pieces from **Focal Light Box** and set aside.

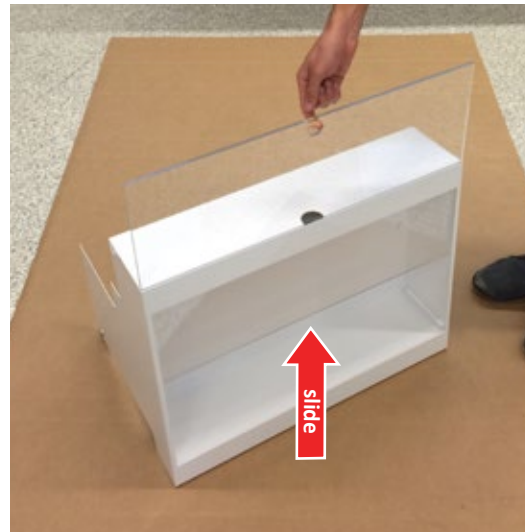

- C. Remove wing nuts and screws from bracket and place aside for later step.

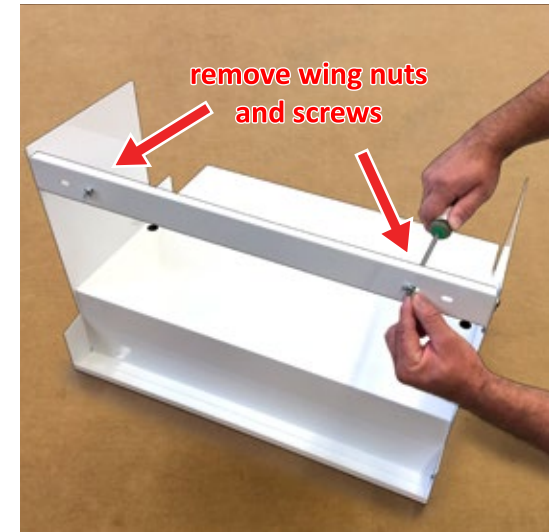

- D. Place LED power plug through hole in **Focal Light Box**, then attach LEDs as shown.



- 2 A. Person 1 places and holds **Focal Light Box** on top shelf while person 2 slightly loosens screws on both sides (*shown without lighted canopy headers installed*).

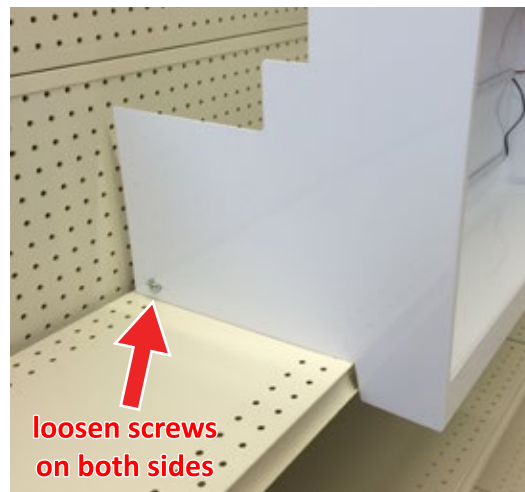

- B. Person 2 aligns bracket to shelf holes, then places screw through bracket and shelf. Repeat on other side of bracket.

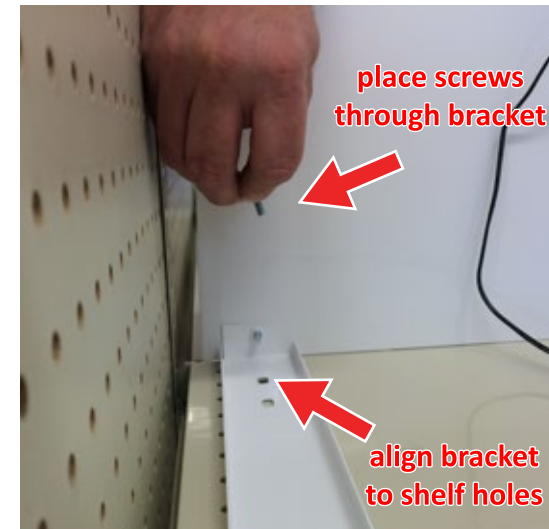

Focal Light Box Installation

(reference **Section Placement Guide** & Rite Aid supplied Plan-O-Gram (POG) for appropriate install locations)

C. Person 2 holds screw with screwdriver.



D. Person 1 tightens wing nut from under the shelf. Repeat for other side.



E. Person 1 makes sure **Focal Light Box** is pushed back while person 2 tightens screws on both sides. Person 1 can let go now.



3 A. Route power cord down behind shelf (*shown without lighted canopy headers installed*).



B. Continue routing power cord down until at splitter shelf. Plug power cord into splitter.



4 A. Verify lights are spaced as shown below. Adjust placement if needed.



Focal Light Box Installation

(reference **Section Placement Guide** & Rite Aid supplied Plan-O-Gram (POG) for appropriate install locations)

B. Using finger holes slide both clear plastic pieces completely into **Focal Light Box**, ensuring bottom engages correctly (*shown without lighted canopy headers installed*).



C. Place graphic in-between clear pieces and slide all the way down (*shown without lighted canopy headers installed*).



* Reference **Section Placement Guide** for appropriate **Focal Light Box** graphic.

Focal Product Display Installation

(reference *Section Placement Guide* & Rite Aid supplied Plan-O-Gram (POG) for appropriate install locations)

- 1 A. Carefully remove **Focal Product Display** contents and place loose items aside until later steps.



- 2 A. With LEDs facing the opening, place LED light strip on the metal bracket.

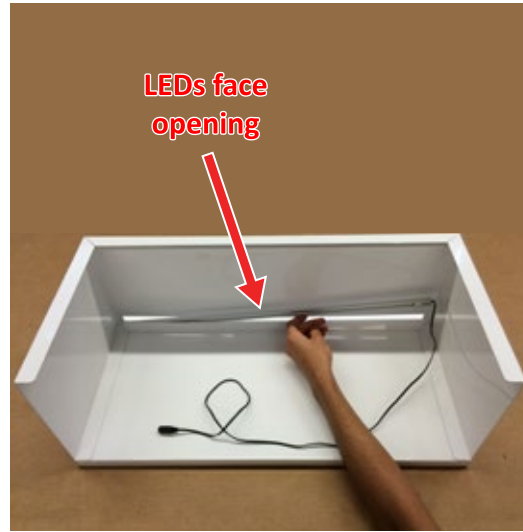

- B. Ensure Light strip is centered and pushed all the way down so it is visible in the opening.



- 3 A. Person 1 lifts **Focal Light Box** and slides **Focal Product Display** partially in. Person 2 routes power cable behind shelves to plug into splitter.

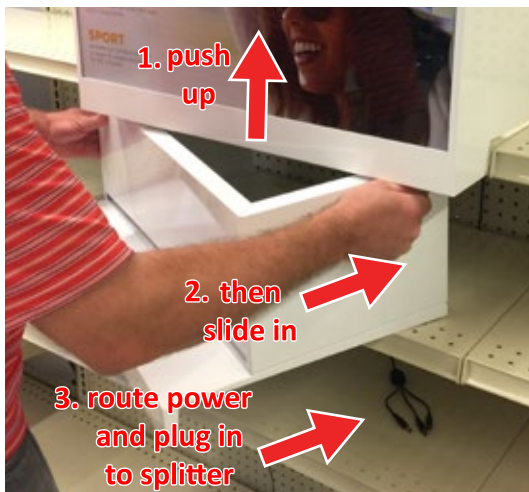

- B. Push **Focal Product Display** back until it hits shelf front, then center it to **Focal Light Box**.



- ! *Next step should be done as one fluid motion.*

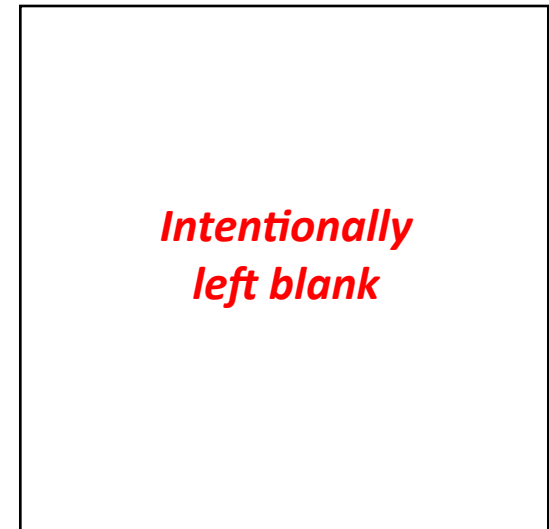

Focal Product Display Installation

(reference *Section Placement Guide* & Rite Aid supplied Plan-O-Gram (POG) for appropriate install locations)

4 A. Top of clear box goes under **Focal Light Box**.

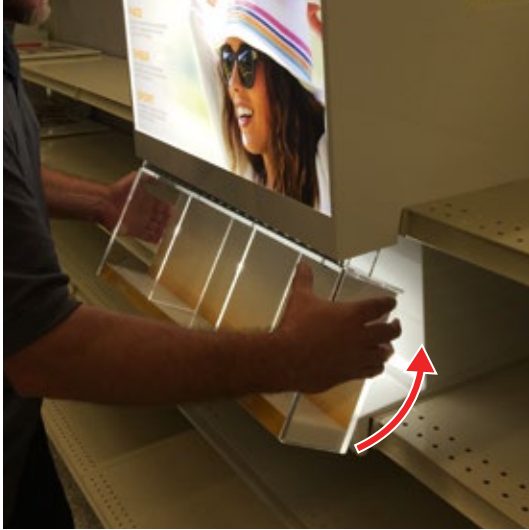

B. Push up to allow clear box to slide into place.

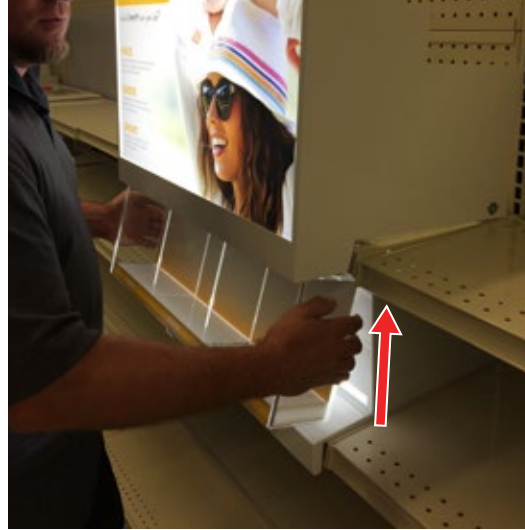

C. Let down while guiding acrylic door tab into slot on metal, which holds the door closed.



5 A. Lift the whole acrylic box up to disengage the door tab so the door can open.



B. Place the 3 **top picks** graphic in each section of the acrylic box. *Store merchandisers will do exact placement when placing product.*



C. Let down while guiding acrylic door tab into slot on metal, which holds the door closed.



Shelf Liner Cubbie Installation

(reference *Section Placement Guide* & Rite Aid supplied Plan-O-Gram (POG) for appropriate install locations)

- 1 When unpacking **Shelf Liner Cubbie**, locate LED light strip, metal divider insert, acrylic dividers and fence and place aside until later steps.

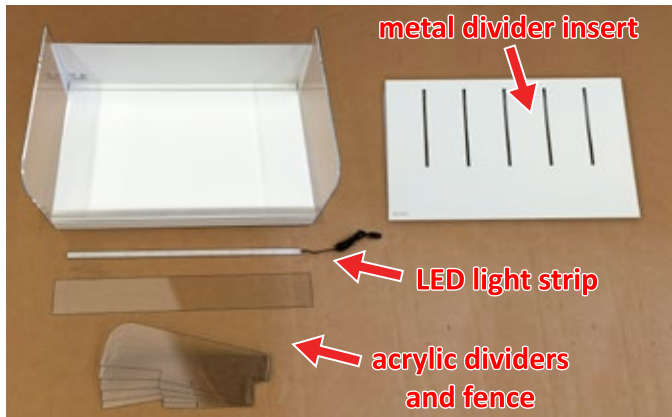

- 2 A. Using a Philips screwdriver, remove both screws/washers and place aside.

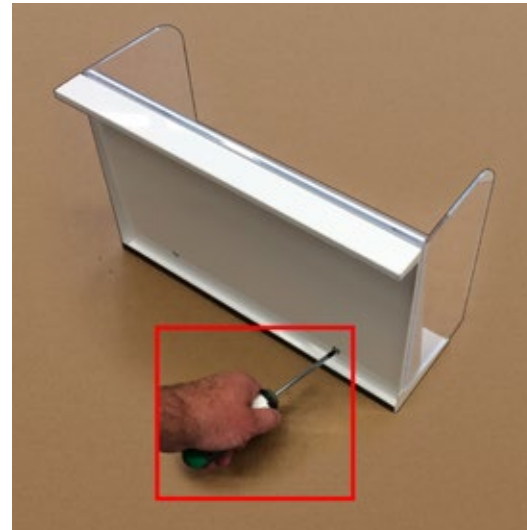

- B. Rotate down and slide plastic shelf forward and then place it aside.



- C. Place LED under metal lip, then route LED connector through hole in **Shelf Liner Cubbie**.

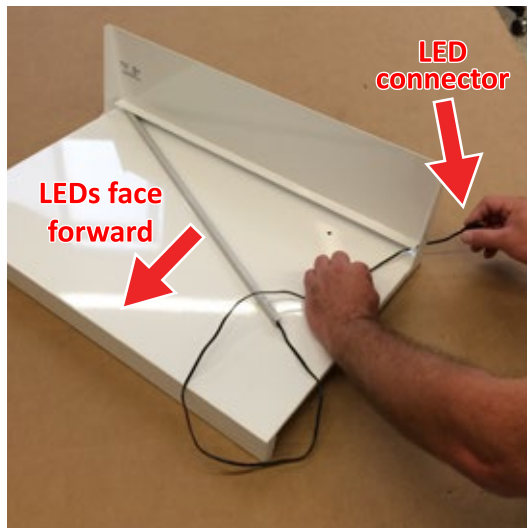

- D. Align magnetic LED strip under lip so it is centered between the two holes.

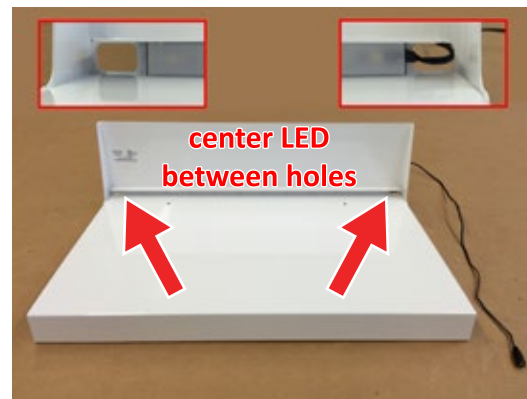

- E. Place metal divider insert on top of plastic shelf and slide forward ensuring engagement with the metal lip.

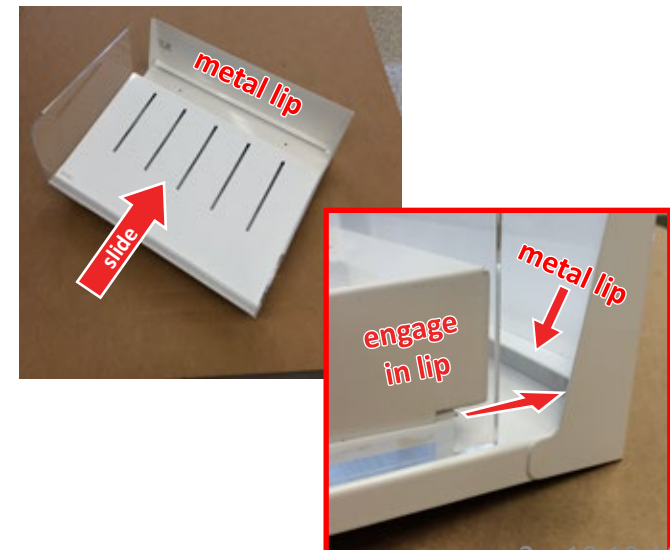

Shelf Liner Cubbie Installation

(reference *Section Placement Guide* & Rite Aid supplied Plan-O-Gram (POG) for appropriate install locations)

F. Carefully rotate back up, then put screws and washers back in **Shelf Liner Cubbie**.

DO NOT OVERTIGHTEN!



3 A. Person 1 slides **Shelf Liner Cubbie** in place while person 2 routes power cord behind shelves to splitter shelf. Plug power into splitter. Push **Shelf Liner Cubbie** back until it hits shelf edge.



B. Place clear dividers in slots on **Shelf Liner Cubbie**.



C. Place clear fence in wedge and push down.

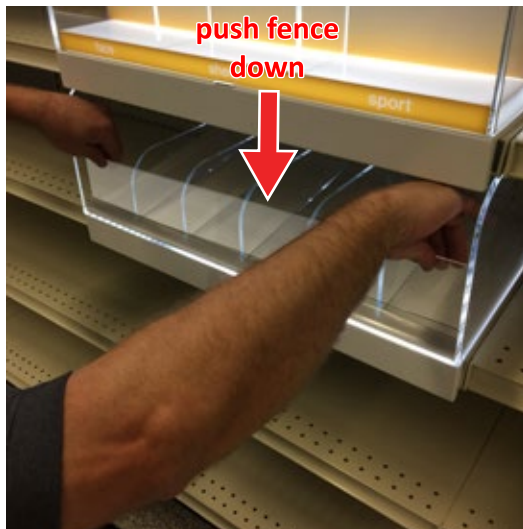

D. Align **Shelf Liner Cubbie** to center with **Focal Light Box**.



E. Place appropriate color strip in extrusion. *NOTE: color strips are packed separately.*

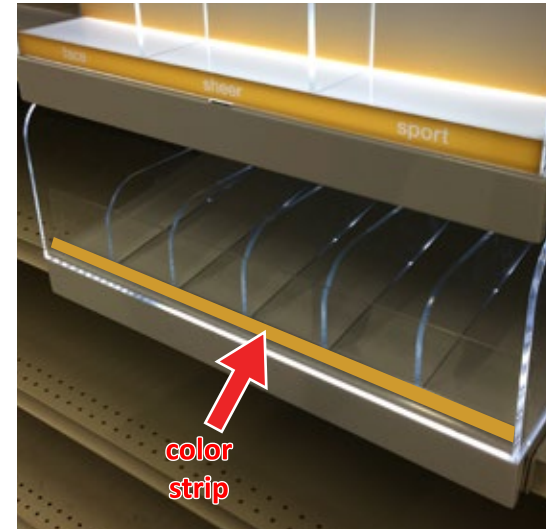

Shelf Liner Installation

- 1 A. When unpacking **Shelf Liner**, locate LED light strip and place aside until later steps.



- 2 A. Using a Philips screwdriver, remove both screws/washers and place aside.

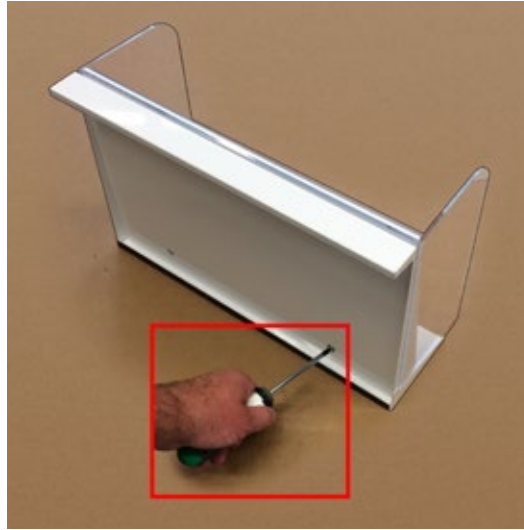

- B. Rotate **Shelf Liner** down, slide plastic shelf forward and then place it aside.

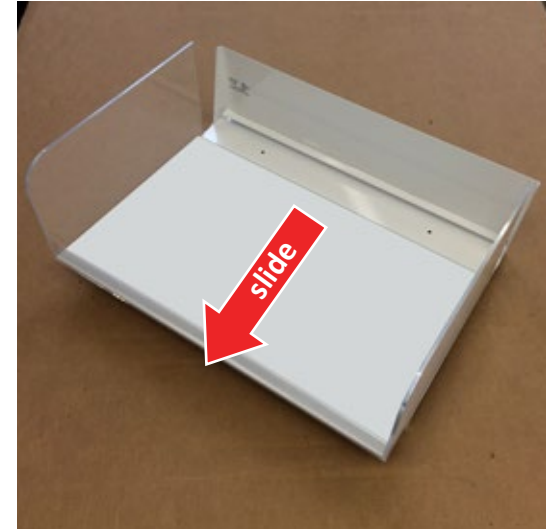

- C. Place LED under metal lip, then route LED connector through hole in **Shelf Liner**.

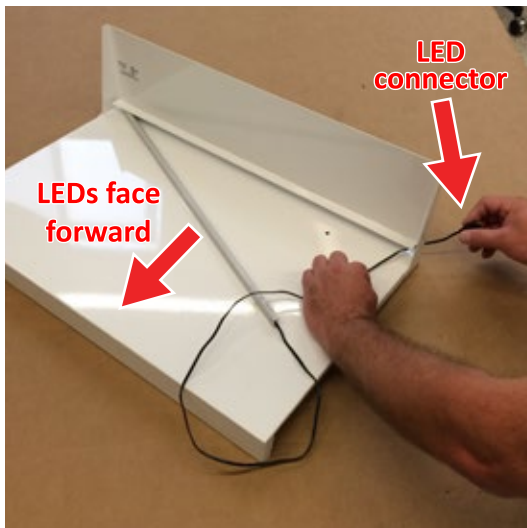

- D. Align magnetic LED strip under lip so it is centered between the two holes.

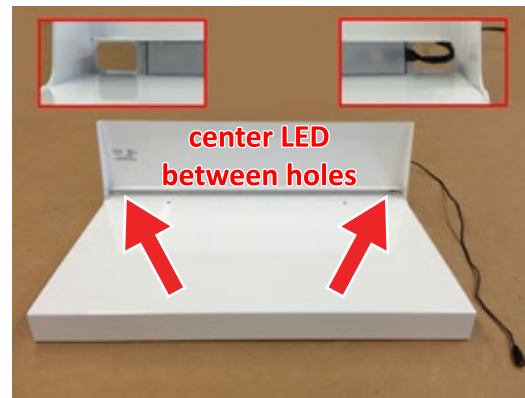

- E. Slide plastic shelf forward so plastic sides engage slots on ends of metal lip.

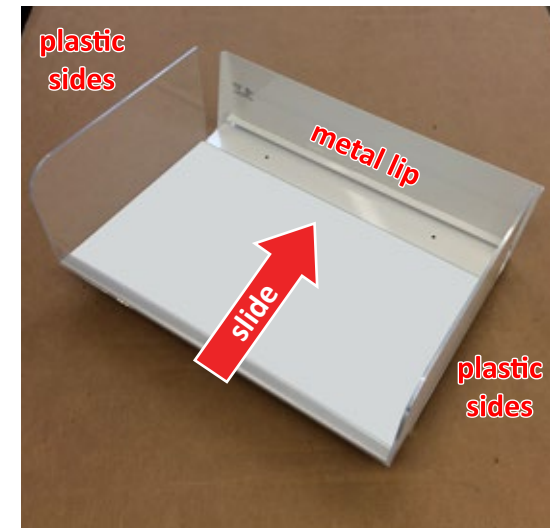

Shelf Liner Installation

F. Put screws and washers back in **Shelf Liner**.

DO NOT OVERTIGHTEN!



3 A. Person 1 slides **Shelf Liner** in place while person 2 routes power cord behind shelves to splitter shelf. Plug power into splitter. Push **Shelf Liner** back until it hits shelf edge.



B. Align **Shelf Liner** to center with **Focal Light Box**.

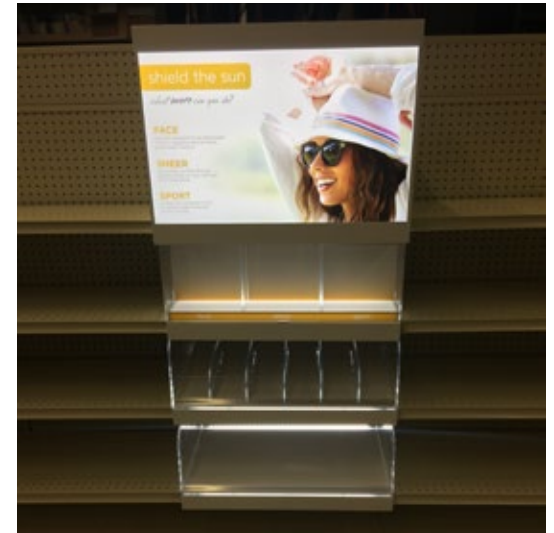

C. Place appropriate color strip in extrusion.
NOTE: color strips are packed separately.

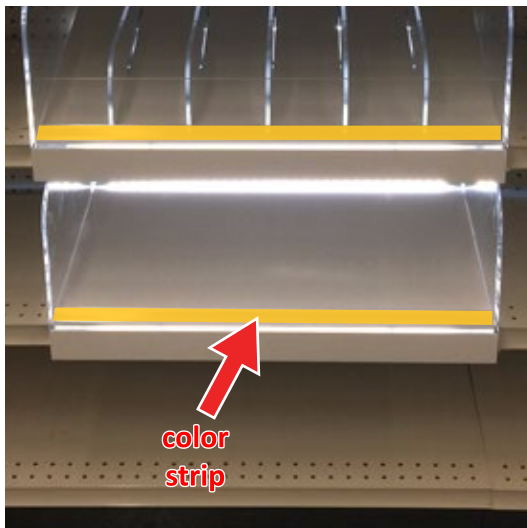

Shelf Wedge Installation

(reference Rite Aid supplied Plan-O-Gram (POG) for appropriate install locations)

! *Shelf wedges have magnetic bases and come with color strip graphics already installed (dual color graphics may need to be flipped - consult POG).*

**Intentionally
left
blank**

1 A. Per Rite Aid supplied POG, place magnetic shelf wedges near front edge of shelves.



B. Align wedges to shelf seams.



! *Dependent on store POG, you may not use all shelf wedges. Unused wedges can be given to Rite Aid store personnel to keep if they deem necessary.*

**Intentionally
left
blank**

Graphic Boxes, Violators & Clear Shelf Inserts

! Give the following items to **Merchandising Associates, who will place on shelves per the Rite Aid POG.**

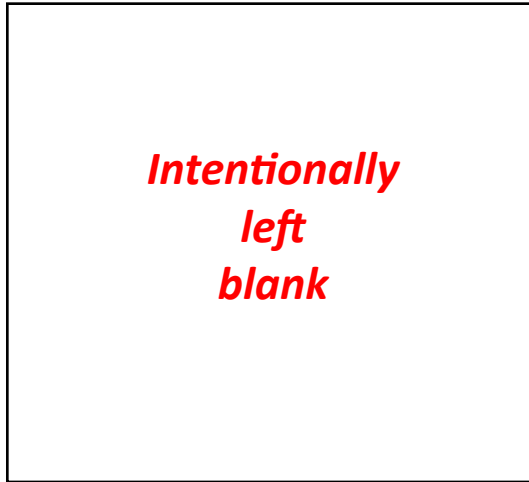

1 A. Attach velcro backed graphics to graphic box structures.
Note box structure orientation

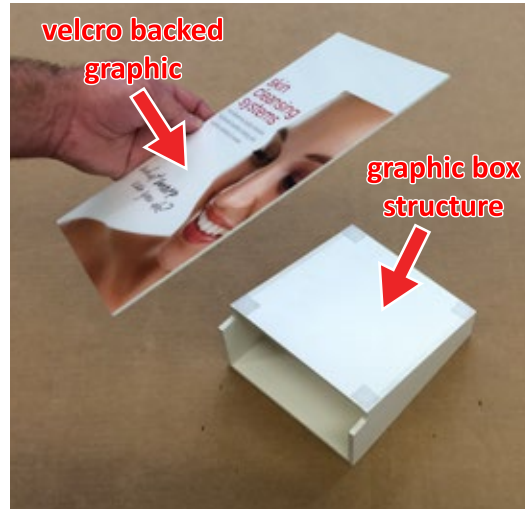

B. Graphic Boxes - Set of 4.



2 Violators - Set of 4.



3 Clear Shelf Inserts - set of 210 various sizes (not all shown).



Endcap - Installation

(reference Rite Aid supplied Plan-O-Gram (POG) for appropriate install locations)

- 1 Place each end cap at end of inline gondola run per the POG. Plug end cap power cord in to store provided power outlet. Level end cap (if necessary) using supplied wrench.



Photo for REFERENCE ONLY - may not match your POG.